

Development of Photogalvanic Cells for Solar Energy Conversion

W. JOHN ALBERY

Department of Chemistry, Imperial College, London SW7 2AY, England

Received August 4, 1981 (Revised Manuscript Received January 20, 1982)

Solar radiation is free but diffuse, and it is unlikely that any solar-energy-conversion device can harvest more than about $500 \text{ W}\cdot\text{m}^{-2}$.^{1,2} Hence to obtain useful amounts of energy one has to cover a large area cheaply. To be competitive at present day prices the cost must be less than $\$100 \text{ m}^{-2}$. This means that the collection device must be as simple as possible. Various possible strategies are shown in Figure 1. In all cases the photon, when absorbed, promotes an electron.

In a photogalvanic cell, the electron is separated from the hole associated with it, and the cell produces energy in the form of electrical power. This power can be stored in a battery or used directly for electrochemical synthesis. Another strategy uses the solar radiation for the photoelectrolysis of water. One advantage of this approach is that the energy is stored as H_2 and can be easily liberated by combination with O_2 . Another advantage is that once H_2 and O_2 are formed on the two electrodes and separated as gaseous products, they do not spontaneously recombine. However, a great disadvantage of this approach is that, because of the diffuse nature of the solar radiation, hydrogen is liberated as tiny bubbles all over a large field, and it will prove difficult to concentrate the hydrogen for reuse.

In the colloidal electrode cell³⁻⁵ there are no plate electrodes but rather colloidal particles of Pt or RuO_2 , which serve as dispersed electrodes. While no current can flow, these ubiquitous electrodes collect the energetic products (Ox and Red) of the primary photoredox reaction before they recombine. A possible device of this sort could liberate both hydrogen and oxygen. However, it suffers from the tiny-bubble-large-field problem with the added hazard that the hydrogen and oxygen bubbles would be in a two-to-one mixture. It may be better to liberate the oxygen and allow the reduced species to accumulate in the electrolyte.⁶ The electrolyte would then have to circulate so that the energy stored in the reduced species would be released, for instance, in a fuel cell. On the other hand, it is not necessary to use oxygen at all; one only needs a system where the energetic species, Ox and Red, are in separate phases so that they cannot recombine. Nonetheless, the electrolyte still would have to circulate in order to concentrate the diffuse solar energy at a point where it can be used.

The great advantage of the photogalvanic cell is that concentration of solar energy is achieved simply by the flow of electrons from the large collecting electrodes. Furthermore for the photogalvanic cell the problems

of collection are separated from those of synthesis, storage, or the electrolysis of water. For these reasons we have chosen to work on photogalvanic cells.

There are two types of photogalvanic cells illustrated in Figure 2. In the semiconductor device^{7,8} solar energy is absorbed in a semiconductor electrode. As shown in Figure 3, the field in the space-charge layer helps to separate the promoted electron from the hole it left behind. For an n-type semiconductor the holes accumulate at the electrode surface. For the efficient operation of the cell, the holes carry out the oxidation of the reduced species in the electrolyte. At the other electrode, the reverse reaction takes place. In this device electrochemical reactions in the electrolyte serve to carry the current. The concentration of holes may be more than a million times that in the bulk of the semiconductor.^{9,10} to drive the necessary current through the interface. This accumulation means instead of carrying out the desired oxidation, the holes oxidize the semiconductor material itself. This is the main disadvantage of this type of cell. A second disadvantage is that the highest efficiencies are achieved with single crystals. Indeed Parkinson, Heller, and Miller¹¹ have shown that a cell consisting of n-type GaAs with a selenide-polyselenide redox system achieves power conversion efficiencies of 12%. That is, 12% of the energy of the incoming solar radiation (including all wavelengths) is converted into electrical energy. However, it is unrealistic to think of covering Arizona with single crystals of n-type GaAs. While cells using powders give efficiencies of about 8%, they can still suffer from problems of corrosion. Unfortunately even a little corrosion is a serious problem. The regular replacement of a large area semiconductor electrode would be uneconomic.

The corrosion problem is not nearly so serious for the second type of photogalvanic cell illustrated in Figure 2. Here the solar radiation is absorbed by a dye in the electrolyte, and it is in this phase the energetic species are made and separated. While photochemical degradation of the dye will take place, it is much easier to replace the electrolyte than the electrodes.

- (1) M. D. Archer, *J. Appl. Electrochem.*, **5**, 17 (1975).
- (2) M. D. Archer and W. J. Albery, *Affinidad*, **346**, 257 (1977).
- (3) K. Kalyanasundaram and M. Gratzel, *Angew. Chem., Int. Ed. Engl.*, **18**, 701 (1979).
- (4) K. Kiwi and M. Gratzel, *Angew. Chem.*, **91**, 659 (1979).
- (5) K. Kalyanasundaram, O. Micic, E. Pramauro, and M. Gratzel, *Helv. Chim. Acta*, **62**, 2432 (1979).
- (6) G. Porter, private communication.
- (7) H. Gerischer, *J. Electroanal. Chem.*, **58**, 263 (1975).
- (8) R. Memming, *J. Electrochem. Soc.*, **125**, 117 (1978).
- (9) D. L. Laser and A. J. Bard, *J. Electrochem. Soc.*, **123**, 1837 (1976).
- (10) W. J. Albery, P. N. Bartlett, M. P. Dare-Edwards, and A. Hamnett, *J. Electrochem. Soc.*, **128**, 1492 (1981).
- (11) B. A. Parkinson, A. Heller, and B. Miller, *Appl. Phys. Lett.*, **33**, 521 (1978).

Wyndham John Albery was born on April 5, 1936. He obtained M.A. and D.Phil. degrees from Oxford University. During 1963-1978, he was a Fellow and Praelector in Physical Chemistry at University College, Oxford, as well as a Lecturer in the Physical Chemistry Laboratory at Oxford. In 1978, he was appointed to his present post as Professor of Physical Chemistry, Imperial College, London.

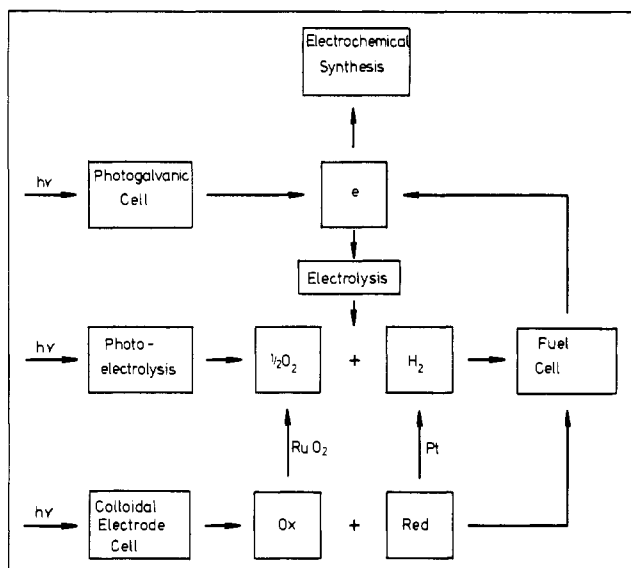

Figure 1. Possible routes for the use of solar energy.

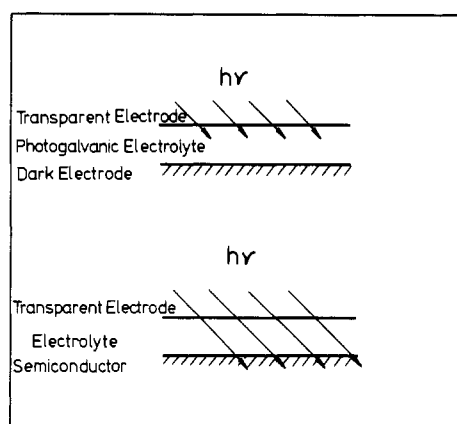

Figure 2. Thin-layer-electrolyte and semiconductor photogalvanic cells.

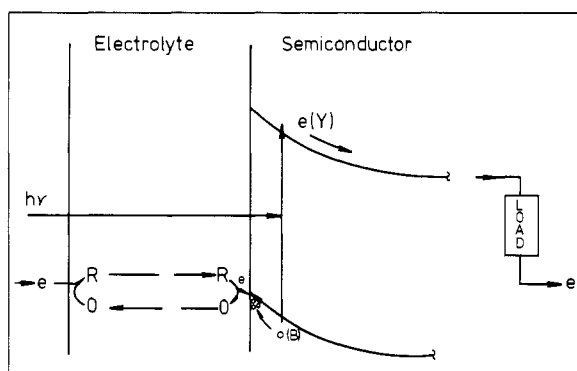

Figure 3. Schematic operation of an n-type semiconductor photogalvanic cell.

Up to now the most successful electrolyte photogalvanic cell involves the iron-thionine system. Lichtin and his co-workers have investigated the effects of variations in pH, temperature, solvent, and electrode materials on the efficiency of this type of cell.¹²⁻¹⁴ The highest efficiency that has been achieved so far is only

(12) N. N. Lichtin in "Solar Power and Fuels", J. R. Bolton Ed.; Academic Press: New York, 1977, p 119 ff.

(13) T. L. Osif, N. N. Lichtin, and M. Z. Hoffman, *J. Phys. Chem.*, **82**, 1778 (1978).

(14) D. E. Hall, J. A. Eckert, N. N. Lichtin, and P. D. Wildes, *J. Electrochem. Soc.*, **123**, 1705 (1976).

0.03%.¹⁵ In this Account, we describe our recent efforts to improve the efficiency of electrolyte photogalvanic cells, based on the iron-thionine system and the iron-ruthenium system.¹⁶

The Reaction Scheme

The general reaction¹⁷⁻¹⁹ for the electrolyte photogalvanic cell involves two redox couples, A,B and Y,Z, dissolved in the electrolyte. One component, A, is a dye that absorbs the solar radiation, whereupon the excited A* undergoes an electron-transfer reaction with Z to form two energetic products, B and Y

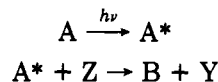

The products B and Y will return by the back reaction to A and Z

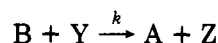

For an efficient cell, before the back reaction occurs, B must find the illuminated electrode, through which the light enters the cell, and react there.



This electrochemical reaction regenerates the dye. Provided that the electrode kinetics of the A,B couple are rapid, the potential of the illuminated electrode will be close to the standard electrode potential of the A,B couple, $E_{A,B}^{\ominus}$.¹⁹ It is also vital that the illuminated electrode should be selective. The photogenerated B must react there, but the reaction of the photogenerated Y must be blocked. If the reaction $Y \pm e \rightarrow Z$ takes place, then the electrode is merely an efficient catalyst for the conversion of B and Y to A and Z! Provided that the illuminated electrode is selective, the photogenerated Y can diffuse across the cell and react on the dark electrode.

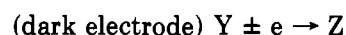

If the electrode kinetics for the Y,Z couple are rapid on this electrode, then the potential of the dark electrode will also be close to the standard electrode potential of the Y,Z couple, $E_{Y,Z}^{\ominus}$. The voltage, E_{Δ} , developed by the cell will then be given by¹⁹

$$E_{\Delta} \approx |E_{A,B}^{\ominus} - E_{Y,Z}^{\ominus}| \quad (1)$$

We have analyzed theoretically the case of the concentration cell¹⁸ where the dark electrode handles the A,B couple rather than the Y,Z couple. The maximum power produced by this cell is only 1 W m^{-2} because the voltage arising from the Nernst $(RT/F) \ln$ terms is only 25 mV. This type of cell is therefore hopelessly inefficient. For an efficient cell we require an illuminated electrode, which selects the A,B couple and blocks the Y,Z couple, and a dark electrode on which the Y,Z couple reacts rapidly.

The reaction sequence is illustrated schematically in Figure 4. There are similarities to the semiconductor

(15) D. E. Hall, W. D. K. Clark, J. A. Eckert, N. N. Lichtin, and P. D. Wildes, *Ceram. Bull.*, **56**, 408 (1977).

(16) C.-T. Lin and N. Sutin, *J. Phys. Chem.*, **80**, 97 (1976).

(17) W. J. Albery and A. W. Foulds, *J. Photochem.*, **10**, 41 (1979).

(18) W. J. Albery and M. D. Archer, *J. Electroanal. Chem.*, **86**, 1 (1978).

(19) W. J. Albery and M. D. Archer, *J. Electroanal. Chem.*, **86**, 19 (1978).

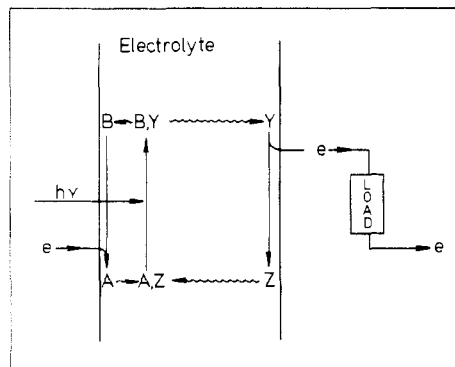

Figure 4. Schematic operation of an electrolyte photogalvanic cell. A typical example would be $A = \text{Ru}(\text{bpy})_3^{2+}$, $B = \text{Ru}(\text{bpy})_3^{3+}$, $Y = \text{Fe}(\text{II})$, and $Z = \text{Fe}(\text{III})$.

Table I
Characteristic Lengths

X_1	distance between electrodes
$X_\epsilon = \epsilon[A]^{-1}$	distance over which light is absorbed
$X_k = (D/k[Y])^{-1/2}$	distance over which B diffuses before being destroyed by reaction with Y
$X_g = (D/\phi I_0 \epsilon)^{-1/2}$	distance over which A diffuses in irradiance I_0 before undergoing a photoredox reaction of quantum efficiency ϕ

cell shown in Figure 3. The species B and Y are equivalent to the hole–electron pair. In each case it is essential for B or the hole to react at the illuminated interface before it recombines with Y or the electron. This is easier to achieve in the semiconductor than in the electrolyte where transport is by the slow process of molecular diffusion. One significant difference is that in the semiconductor the field in the space-charge layer separates the electrons and holes. In the electrolyte cell this separation has to be achieved by the selective electrode kinetics at the illuminated electrode. Another difference is that in the electrolyte cell the changes in potential are found across the Helmholtz layers at the two electrodes; the electrode kinetics are controlled, as in normal electrochemistry, by the effect of their potential differences on the electrochemical rate constants. With the semiconductor, on the other hand, the potential drop is found across the space-charge layer; the rate of the interfacial reaction can now only be changed by increasing (or decreasing) the concentration of holes, leading thereby to the corrosion problems noted above.

The Characteristic Lengths

In our theoretical analysis of the electrolyte photogalvanic cell^{17–20} we solved the differential equations describing the absorption of the solar radiation and the photogeneration of B, its reaction with Y, and its transport by diffusion to the illuminated electrode. In describing the results, it is helpful to use the characteristic lengths listed in Table I and illustrated in Figure 5. For an efficient cell we have shown that the following condition must hold

$$10X_\epsilon < X_k, X_g, X_1 \quad (2)$$

First, X_ϵ must be smaller than X_k so that B is generated close enough to the illuminated electrode to reach it before being destroyed by the back reaction with Y. Second, X_ϵ must be smaller than X_g in order to ensure

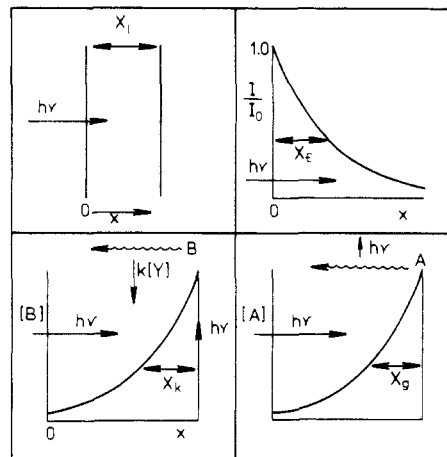

Figure 5. The four characteristic lengths defined in Table I.

Table II
Recipe for an Efficient Cell

$X_1 \sim 10^{-2}$ cm	gives $[Y] \sim 10^{-2}$ M
$X_\epsilon \sim 10^{-4}$ cm	gives $[A] \sim 10^{-1}$ M
$X_k \sim 10^{-3}$ cm	gives $k[Y] \sim 10$ s ⁻¹
	and $k < 10^3$ M ⁻¹ s ⁻¹

that the incoming solar radiation does not bleach the solution close to the illuminated electrode and to ensure that there will always be sufficient A on hand to absorb the incoming photons. Third, X_ϵ must be smaller than X_1 so that all the light is absorbed in the cell and so that B reacts at the illuminated electrode rather than the dark electrode.

The length X_g is about 10^{-3} cm.²⁰ This means that we can define fairly closely the recipe for success given in Table II. For ease of construction we have taken the value of X_1 to be 10^{-2} cm. Since Y must diffuse across the cell, this length determines the concentration of Y at the illuminated electrode, which, in turn, allows us to estimate the limit for the second-order rate constant k . Since Y and Z have to diffuse further than B, they must be present in larger concentrations. Not only must there be sufficient Z to diffuse across the cell without causing concentration polarization, but also the concentration of Z must be large enough to trap A* efficiently. Hence, in characterizing a photogalvanic system we must measure the Stern–Volmer constant, K_q , for the following scheme:

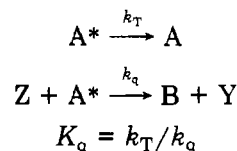

Since increasing the concentration of Z reduces the voltage of the cell because of the Nernst term, we wish to keep the concentration of Z as small as possible, providing always that it is sufficient both to trap A* and to prevent concentration polarization.

The Transparent Rotating Disc Electrode

In order to investigate photoredox systems to see if they meet the criteria in Table II, we have developed the technique of the transparent rotating disk electrode,^{21–24} In this technique we make a transparent

(20) W. J. Albery and M. D. Archer, *Nature (London)*, **270**, 399 (1977).

(21) W. J. Albery, M. D. Archer, N. J. Field, and A. D. Turner *Discuss. Faraday Soc.* **56**, 28 (1973).

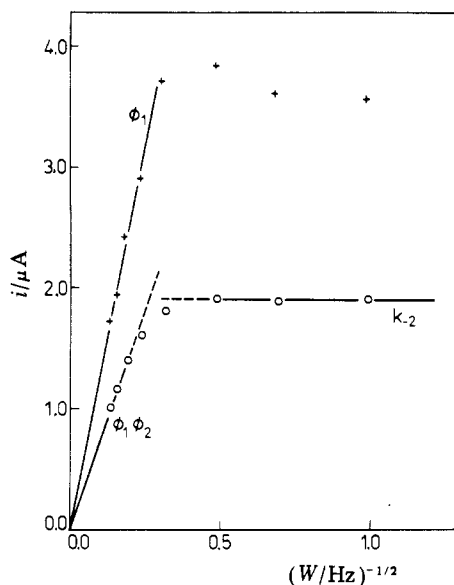

Figure 6. Typical variation of photocurrents from an iron-thionine system with rotation speed at a rotating transparent-disk electrode. For the upper curve (+) there was no added Fe(III), and one obtains ϕ_1 from the results at high W ; at low W the solution bleaches. For the lower curve [Fe(III)] = 4.4 mM; at high W one obtains $\phi_1\phi_2$, and at low W one obtains k_{-2} for the photostationary state established in the thicker diffusion layer.

SnO₂ electrode on the end of a quartz rod, through which the light enters the cell. The electrode is rotated so that a constant supply of fresh reactants are brought to the electrode surface. Furthermore, from the known hydrodynamics of the rotating disc system,²⁵ the concentration profiles in the solution can be calculated. In particular, the thickness of the stagnant layer, X_D , adjacent to the electrode can be calculated from the Levich equation²⁶

$$X_D = 0.64D^{1/3}\nu^{1/6}W^{-1/2} \quad (3)$$

where ν is the kinematic viscosity and W (in Hz) is the rotation speed. Within the stagnant layer transport is by diffusion; outside the layer the solution is well-stirred. This technique allows us to study the whole photogalvanic system in the steady state with the added advantage that the rotation speed, W , can be used to control X_D .

In investigating photogalvanic systems, we perform two types of experiment. In the first experiment we do not add any Y to the solution. Under these conditions the concentration of photogenerated Y is so small that the back reaction of B with Y is usually negligible. The potential of the electrode is set to detect all the photogenerated B that reaches the electrode. The photocurrent then varies linearly with $W^{-1/2}$ (see Figure 6). The current is lower at high rotation speeds because to reach the electrode B must be photogenerated inside the stagnant layer; most of the B generated outside the layer is swept away into the solution. Hence the slower

Table III
Parameters Required to
Characterize a Photogalvanic System

D	limiting current; exhaustive electrolysis ^a
ϕ, K_q	transparent disk electrode: gradient of i_p vs $W^{-1/2}$; modulation of light
k	transparent disk electrode: flash electrolysis; stopped flow

^a The advantage of this technique³¹ is that the result does not depend on the concentration or the number of electrons in the electrochemical reaction.

Scheme I^a

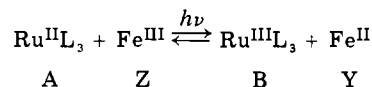

^a System I, L = 2,2'-bipyridine (bpy); system II, L = 3,4,7,8-tetramethylphenanthroline (phen).

the rotation speed, the thicker the stagnant layer (eq 3) and the higher the current. Therefore when the photocurrent varies with $W^{-1/2}$ we can conclude that the back reaction is negligible,^{22,27} and from the size of the photocurrent we can measure the overall quantum efficiency, ϕ , for the production of B. Furthermore, by studying the variation of the photocurrent, i_p , with the concentration of quencher Z and plotting i_p^{-1} against $[Z]^{-1}$, we can measure the Stern-Volmer constant K_q :

$$\phi/\phi_{\infty} = 1 + K_q/[Z] \quad (4)$$

Electrochemical detection, rather than fluorescence quenching, is a much more direct method of obtaining these results. Indeed this electrochemical technique is ideal for distinguishing between electron and energy transfer. At low rotation speeds, as shown in Figure 6, the photocurrent may become independent of rotation speed. This is because at low W , X_D is greater than X_g , the supply of A from the bulk solution is too slow to absorb all the incoming photons, and the dye in the diffusion layer is bleached.

In the second type of experiment with the transparent disk electrode, Y is added to the solution. Two pieces of information can be obtained from these experiments. First, if the current varies with $W^{-1/2}$ and there is a change in the gradient, then Y is affecting the quantum efficiency for the generation of B. Second, when sufficient Y is added so that the back reaction is significant, then a photostationary state is established inside the stagnant layer. The current is then independent of rotation speed, and from its size one can measure k , the rate constant for the back reaction (Figure 6). We can also measure k using stopped-flow and flash electrolysis. The latter technique^{28,29} is like flash photolysis with electrochemical detection. The species B and Y are photogenerated by a flash (in our case from a camera flash)²⁷ passing through a stationary transparent disk electrode. After the flash, the decay of the current from B is measured. Results for the measurement of k by the three different techniques are in reasonable agreement.^{27,30}

(22) W. J. Albery, M. D. Archer, and R. G. Egdell, *J. Electroanal. Chem.*, **82**, 199 (1977).

(23) W. J. Albery, W. R. Bowen, F. S. Fisher, and A. D. Turner, *J. Electroanal. Chem.*, **107**, 1 (1980).

(24) W. J. Albery, W. R. Bowen, F. S. Fisher, and A. D. Turner, *J. Electroanal. Chem.*, **107**, 11 (1980).

(25) V. G. Levich, "Physicochemical Hydrodynamics", Prentice Hall, Englewood Cliffs, NJ 1962, p 60.

(26) V. G. Levich, "Physicochemical Hydrodynamics", Prentice Hall, Englewood Cliffs, NJ 1962, p 68.

(27) W. J. Albery, P. N. Bartlett, W. R. Bowen, F. S. Fisher, and A. W. Foulds, *J. Electroanal. Chem.*, **107**, 23 (1980).

(28) J. R. Birk and S. P. Perone, *Anal. Chem.*, **40**, 496 (1968).

(29) S. S. Fraton, Jr., and S. P. Perone, *J. Electrochem. Soc.*, **123**, 1672 (1976).

(30) W. J. Albery, P. N. Bartlett, J. P. Davies, A. W. Foulds, A. R. Hillman, and F. Souto-Bachiller, *Faraday Discuss. Chem. Soc.*, **70**, 341 (1980).

Table IV
Results for ϕ and k

	ϕ	$k/(\text{dm}^3 \cdot \text{mol}^{-1} \cdot \text{s}^{-1})$
system I	0.95 ± 0.05	4.8×10^6
system II	0.95 ± 0.05	5.4×10^4

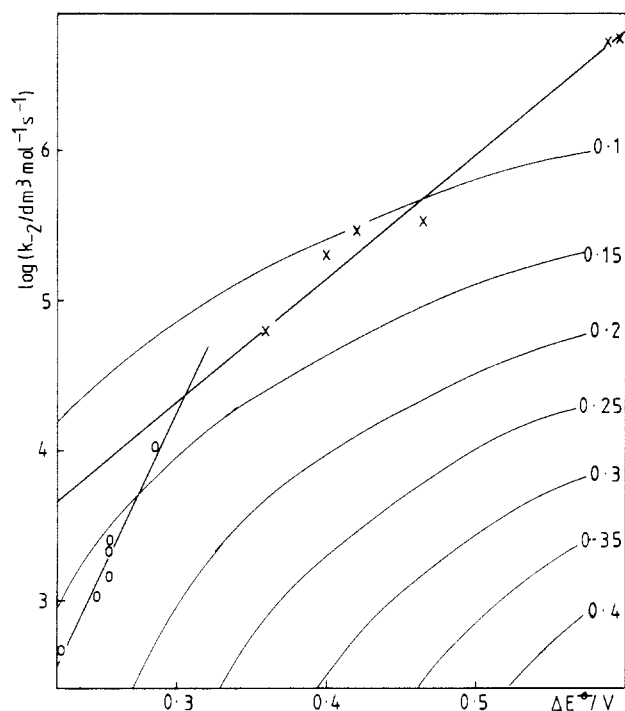

Figure 7. Linear-free-energy relationship between the rate constants for the back reaction of various ruthenium complexes (X) and of various thiazine dyes (O) as a function of the output voltage of a photogalvanic cell based on the iron-ruthenium or the iron-thiazine system. The contours show the fraction of photogenerated species that reach the illuminated electrode.

In Table III we summarize the parameters necessary to characterize a photogalvanic system and the techniques²¹⁻³¹ we use to study them. For some systems the back reaction is so fast that the photocurrent is never proportional to $W^{-1/2}$. For these systems values of ϕ can be found by modulating the light source and measuring the resulting phase shift and amplitude of the photocurrent.^{23,24}

The Iron-Ruthenium System

Following a suggestion of Sutin et al.¹⁶ we decided that the iron-ruthenium system was sufficiently interesting to merit investigation (Scheme I). Our values for k were in good agreement with those obtained by Sutin.³² The results are collected in Table IV. The quantum efficiency ϕ is close to its optimum value of unity, but the problem is that the rate constants are over an order of magnitude larger than the critical value of 10^3 in Table II. By choosing different ligands the rate constant can be reduced, but unfortunately this also reduces the cell voltage. Figure 7 shows a linear-free-energy relation between the rate constant and ΔE^0 . We find that for $k/(\text{dm}^3 \cdot \text{mol}^{-1} \cdot \text{s}^{-1}) = 10^3$ the cell voltage given by ΔE^0 would only be 0.14 V. Two other disadvantages of the iron-ruthenium system are that a sufficiently

(31) M. L. Hitchman and W. J. Albery, *Electrochim. Acta* 17, 787 (1972)9.

(32) C.-T. Lin, W. Botcher, M. Chou, C. Creutz, and N. Sutin, *J. Am. Chem. Soc.*, 98, 6536 (1976)9.

Scheme II

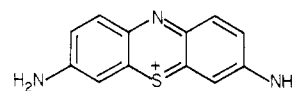
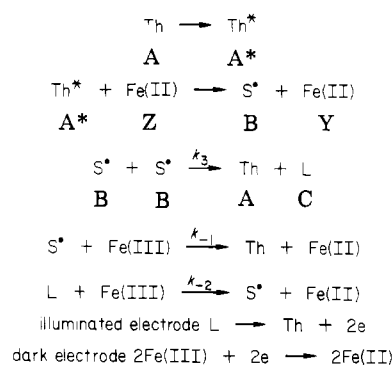

Th

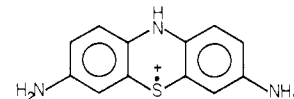

S

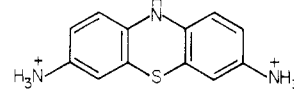

L

selective electrode is not known and that ruthenium compounds are relatively expensive. We therefore have preferred to concentrate our work on the development of the iron-thionine system.

The Iron-Thionine System

The reaction scheme for iron-thionine system is shown in Scheme II.

We have carried out a general analysis of this type of photoredox system.^{33,34} From the original data of Hatchard and Parker,³⁵ from flash photolysis results,³⁶ and from steady-state measurements,²⁴ there is little doubt that the iron-thionine system reacts by the mechanism depicted above.

The overall quantum efficiency for the production of L, ϕ , is given by

$$\phi = \phi_1 \phi_2 \quad (5)$$

where ϕ_1 describes the quantum efficiency for the generation of S \cdot and ϕ_2 is the fraction of S \cdot that forms L. The ferric ion (Y) can intervene at two stages, either by destroying L before it reaches the electrode (the usual back reaction) or by cutting off S \cdot before it is converted to L (effect on ϕ_2). Our results^{27,30,34} suggest that the back reaction is still the main problem rather than the effect on ϕ_2 (see Figure 6).

For the iron-thionine system we find that $\phi_1 = 0.55$. Results from a variety of techniques show that $k_q/(\text{mol} \cdot \text{dm}^{-3}) = 4 \times 10^{-3}$ and $k_{-2}/(\text{dm}^3 \cdot \text{mol}^{-1}) = 500$. These values are acceptable. However, one of the main problems of thionine is its low solubility in water.¹⁷

(33) W. J. Albery, W. R. Bowen, and M. D. Archer, *J. Photochem.*, 11, 15 (1979).

(34) W. J. Albery, W. R. Bowen, M. D. Archer, and M. I. C. Ferreira, *J. Photochem.*, 11, 27 (1979).

(35) C. G. Hatchard and C. A. Parker, *Trans. Faraday Soc.*, 54, 1093 (1961).

(36) M. I. C. Ferreira and A. Harriman, *J. Chem. Soc., Faraday Trans. 1.*, 73, 1085 (1977).

Table V
Properties of Disulfonated Thionines at 25 °C in 0.05 M H₂SO₄

	thionine	DST-1	DST-2	DST-4	DMST-1	DMST-2
$\lambda_{\text{max}}/\text{nm}^a$	599	585	580	593	615	626
$\epsilon/(\text{cm}^2 \cdot \mu\text{mol}^{-1})^b$	129	161	115		181	184
$K_q/(\text{mmol} \cdot \text{cm}^{-3})^c$	4.0	1.0	1.0		3.3	
ϕ_1^d	0.55	0.56	0.44		0.2	0.65
$k_{-2}/(\text{dm}^3 \cdot \text{mol}^{-1} \cdot \text{ms}^{-1})^e$	0.47	1.0	2.2	10	0.5	2.5
$E_{1/2}/\text{mV}^f$	208	188	177	145	163	164

^a λ_{max} is the wavelength of maximum absorption. ^b ϵ is the extinction coefficient at the maximum absorption in natural logarithmic units. ^c K_q is the Stern-Volmer constant for quenching by Fe(II) to give the photoredox reaction. [Fe(II)] must be greater than $10K_q$. ^d ϕ_1 is the quantum efficiency for production of S[•] (assuming there is sufficient Fe(II)). ^e k_{-2} is the rate constant for L + Fe(III), and should be smaller than $1 \text{ dm}^3 \cdot \text{mol}^{-1} \cdot \text{ms}^{-1}$. ^f $E_{1/2}$ is half-wave potential for the reduction of Th measured with respect to a saturated calomel electrode: since the systems are reversible, $E_{1/2} \approx E^\ominus$.

This means that, despite a satisfactory value of k_{-2} , from the point of view of the criteria in Table II, the absorption length X_ϵ is much greater than X_k . Hence, we decided to retain the thiazine nucleus (because it has good light absorption characteristics, a reasonable ϕ_1 , a good k_q , a good k_3 , and a reasonable k_{-2}) and make the dye more soluble by attaching sulphonate groups.

Synthesis of Modified Thiazine Dyes

We have developed³⁷ Bernthsens' synthesis of methylene blue³⁸ so that we can couple two different monomers to form sulfonated thiazine dyes. So far we have made and characterized five different disulfonated isomers. Three of these, DST-1, DST-2, and DST-4, are disulfonated thionines, while DMST-1 and DMST-2 also have methyl substitution on the nitrogens.³⁷

All of these isomers are considerably more soluble than thionine, and we estimate the concentrations up to $3 \times 10^{-2} \text{ M}$ can be achieved. In Table V we have collected values for the parameters required to assess the suitability of the isomers for use in a photogalvanic cell.

Introduction of the sulfonate groups shifts E^\ominus to more negative values; this is desirable since it increases the voltage of the cell. However there is a correlation between the rate constant for the back reaction, k_{-2} and $E_{1/2}$. The linear-free-energy relation (LFER) is shown in Figure 7. The slope of the line corresponds to $\alpha = 1.2$, which is unfortunate since this implies that we cannot increase the cell voltage without increasing k_{-2} beyond the critical value of 10^3 . Detailed analysis³⁰ shows that even if the solubility was increased so that X_ϵ was 10^{-4} cm , the efficiency of the cell would only be 1%.

We must therefore hope to find exceptions to the LFER in Figure 7; indeed it is interesting that DMST-1 lies below the line, and for this reason this compound merits further investigation. It is also possible that other electron-releasing groups such as methoxy may decrease $E_{1/2}$, thereby increasing the voltage of the cell, without affecting k_{-2} as much. We are currently investigating these compounds. The fact that k_{-2} is concerned with the relative stabilities of L and S[•], whereas E^\ominus involves L and Th, means that we must search for substitution which destabilizes both L (thereby increasing ΔE^\ominus) and S[•] (having no effect on k_{-2}).

In summary: disulfonation has produced isomers that are nearly soluble enough, that do not dimerize, and

(37) W. J. Albery, P. N. Bartlett, A. W. Foulds, F. A. Souto-Bachiller, and R. Whiteside, *J. Chem. Soc., Perkin Trans. 2*, 1981, 794.

(38) A. Bernthsen, *Chem. Ber.*, 17, 2854 (1884).

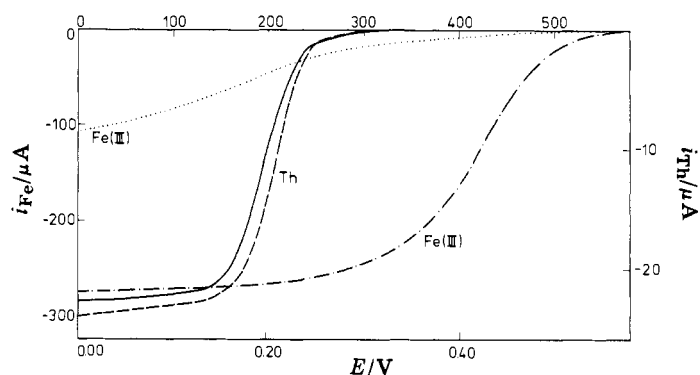

Figure 8. The effect of modifying the electrode with coated thionine on the electrode kinetics of Th and Fe(III); clean Pt electrodes (--- and -.-), modified electrode (··· and —).

that have many of the required kinetic characteristics. However, to increase the cell voltage it is necessary to find substituents that shift E^\ominus to more negative values, but which have little effect on k_{-2} .

Electrode Selectivity

We now turn to the problem of the selectivity of the illuminated electrode; the photogenerated leucothionine must react efficiently on the illuminated electrode while the reaction of Fe(III) is blocked. We have shown that this, selectivity can be achieved by using a thionine-modified electrode.³⁹⁻⁴¹ Up to 20 layers of thionine can be irreversibly coated on to an electrode made of Pt, Au, or SnO₂ by holding the electrode at about 1.1 V for several minutes in a thionine solution. Current-voltage curves for the reduction of thionine and of Fe(III) on clean and on coated electrodes are shown in Figure 8. The coating process hardly affects the electrode kinetics of the thionine reduction, while the current-voltage curve for the Fe(III) reduction is shifted and much reduced. Recent work by Archer⁴² confirms these conclusions. This is exactly the type of electrode we need for an effective photogalvanic cell.^{39,41}

The selective electrode kinetics of the thionine-coated electrode extends to other systems. For instance, the coating hardly affects the kinetics of organic systems such as quinone/hydroquinone, but other inorganic systems, such as the reduction of Ru(bpy)₃³⁺, are blocked. Ring-disk experiments⁴³ on inorganic systems

(39) W. J. Albery, A. W. Foulds, K. J. Hall, A. R. Hillman, R. G. Egdell, and A. F. Orchard, *Nature (London)* 282, 793 (1979).

(40) W. J. Albery, R. G. Egdell, and A. F. Orchard, *J. Electroanal. Chem.*, 107, 37 (1980).

(41) W. J. Albery, A. W. Foulds, K. J. Hall, and A. R. Hillman, *J. Electrochem. Soc.*, 127, 254 (1980).

(42) M. D. Archer, private communication.

Table VI
Factors Affecting Efficiency of Photogalvanic Cells

	single dye cell, ^a $X_e \approx 10^{-3}$ cm	single dye cell, ^b $X_e = 10^{-4}$ cm	best ^c possible	semicon- ductor cell
absorption of radiation	$1/8$ ^d	$1/8$ ^d	$1/2$ ^e	$1/2$ ^e
quantum efficiency, ϕ_1 ^f	$1/2$	$1/2$	$1/2$	1
collection efficiency ^g	$1/2$	$3/4$	$3/4$	1
voltage factor ^{g,h}	$1/8$	$1/4$	$1/4$	$1/2$
overall efficiency	0.4%	1.0%	4%	25%

^a Existing dyes have $X_e \sim 10^{-3}$ cm. ^b Target is $X_e = 10^{-4}$ cm. ^c More radiation is absorbed by use of dye cocktail or of sensitizers. ^d A single thiazine dye absorbs only one-eighth of the total insolation. ^e An ideal cocktail or semiconductor should absorb \sim one-half of the total insolation. ^f The ideal value should be unity, but results for thiazine dyes show $\phi_1 \approx 0.5$. ^g The values for electrolyte cells are obtained by differentiation to find the optimum power point with the optimum concentrations. ^h The ideal cell should produce 1.8 V, but trying to achieve larger voltages for electrolyte cells leads to lower collection efficiencies.

show that the ions are reduced by direct reaction with the leucothionine present in the coat rather than with the metal electrode.⁴⁴ This explains why the current-voltage curves are shifted close to the E^\ominus for thionine/leucothionine.

We have found that the disulfonated thionines will not coat on the electrode. However, we have shown that the disulfonated thionines do have fast electrode kinetics on a thionine-coated electrode. This raises the interesting possibility of developing a specially substituted thionine for the coat. By attaching electron-releasing groups, the E^\ominus of the coating dye could be shifted to negative values, thereby leading to even more efficient blocking of the Fe(III) reduction. The fact that thionine-coated electrodes can be made easily and that they have the right selective electrode kinetics for the photogalvanic cell are further advantages of the iron-thionine system.

Concluding Remarks

We now summarize the progress made on the various factors affecting the efficiency of the iron-thionine photogalvanic cell. First, the crucial problem of electrode selectivity is nearly solved. Second, progress has been made in the reduction of X_e . Values of 10^{-3} cm can now be achieved, but to have a worthwhile cell the distance must be further reduced to 10^{-4} cm. Third, with the more soluble dyes we expect that the collection of the photogenerated B from the solution to the electrode will be reasonably efficient. However, we wish to find dyes which are exceptions to the linear-free-energy relation in Figure 7. The remaining problems and their effects on efficiency are summarized in Table VI. It can be seen that to achieve worthwhile efficiencies not only is it necessary to reduce X_e to 10^{-4} cm, but also one must absorb more of the solar radiation, through the use of sensitizers⁴⁵ or mixtures of dyes⁴⁶ (the cocktail). Compared to the semiconductor cell it is likely that electrolyte cells will always be less efficient. However, they should be cheaper and easier to maintain.

(43) W. J. Albery and M. L. Hitchman, "Ring-Disc Electrodes", Clarendon Press, Oxford, 1971.

(44) W. J. Albery, *Philos. Trans. R. Soc. London, Ser. A*, **302**, 221 (1981).

(45) P. D. Wildes, D. R. Hobart, and N. N. Lichtin, *Sol. Energy*, **19**, 567 (1977).

(46) N. N. Lichtin, P. D. Wildes, T. L. Osif, and D. E. Hall, *Adv. Chem. Ser.*, No. 173, 296 (1979).

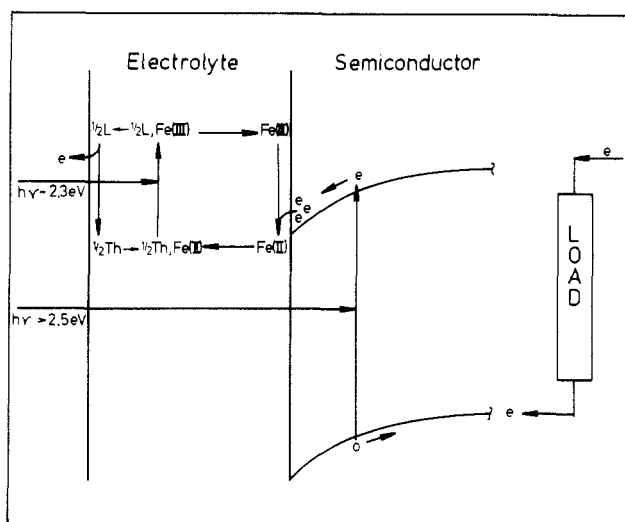

Figure 9. A possible hybrid cell using both a photogalvanic electrode and a p-type semiconductor.

As a long-term aim we are hoping to overcome the problems of the voltage factor and of the absorption of radiation by developing a hybrid cell which would contain a photogalvanic electrolyte together with a p-type semiconductor, as shown in Figure 9. The advantages of this cell are that the dyes absorb the radiation close to the maximum irradiance while the semiconductor absorbs the high-energy tail. Hence the band gap of the semiconductor does not have to be as small as that for a single-shot semiconductor cell, and this should ease the problems of corrosion. Larger cell voltages are obtained from such a cell, since voltage is developed at each electrode. This two-shot cell does not require beam splitters. It has similarities to the hybrid cell being developed by Tien et al.⁴⁷ We calculate that the efficiency of our hybrid cell could be as large as 12%.

I am grateful to the following people who have contributed to the work reported here: Dr. Souto-Bachiller and Dr. Wilson for the synthesis of the modified thiazine dyes, Dr. Fisher, Dr. Foulds, Dr. Bartlett, and Mr. Davies for the kinetic characterization, Dr. Hillman, Mr. Colby, and Mr. Boutelle for the development of the modified electrodes, and Mr. Orchard and Mr. Egdell for taking the XPS spectra. I am also grateful to Dr. Foulds for help in the preparation of this manuscript. We thank the SRC, NRDC, and BP for financial support.

(47) H. Tien and J. M. Mountz, *Energy Res. Abstr.*, **2**, 197 (1978).